



Maintenance and cleaning guide

09. 2022

1 | Handling and installation of the top

During handling, transport and installation of the finished top the greatest care should be taken to prevent any undue bending and twisting or impacts, especially on the edges.

1.1 Handling

After opening the wooden crate or frame in which it was delivered, handle the Laminam top keeping it in a vertical position and with any openings upward.

Never hold it by the openings, in order to avoid cracks or breaks caused by irregular twisting due to incorrect handling. If the top includes a preassembled basin, always support the weight of the basin to prevent it from causing the top to twist.

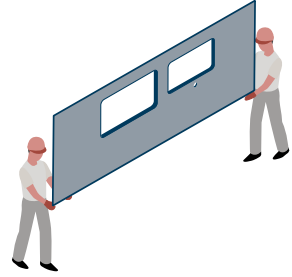

1.2 Installation

Check that the bases of the kitchen unit are perfectly level and fixed together. This is important as they must provide even support for the top. Where the bases do not provide perimeter support for the top, support of an adequate size and material to bear the weight of the top in use must be added between them. This reinforcement should be implemented even when there is a 45° join between two sections of the top.

To prevent any damage during installation, when handling the top it is recommended to support the lower part with a wood panel until it is placed on its base/uprights. If the top includes an integrated basin, particular care should be taken when it is positioned horizontally ready to be placed onto the kitchen unit base.

The weight of the basin should always be supported until the top is securely fitted, making sure that the kitchen units have the required perimeter support and immediately putting the basin supports into place.

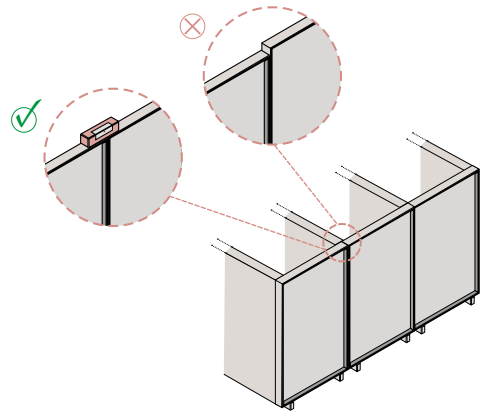

Hold together with a screw or clamp

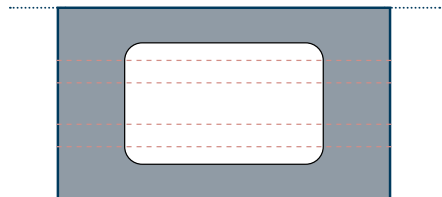
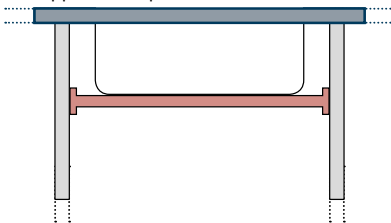

If the unit has sliding drawers, the supports must be appropriately shaped, to ensure the drawers can slide freely.

If the top has a special shape, or the unit or base cannot provide adequate support, a board, usually in wood, can be placed on or between them to ensure an even, uniform surface for the top.

When installing the top, it is recommended to leave a gap of 2-3 mm from the wall and to fill it with silicone, making sure it is evenly spread.

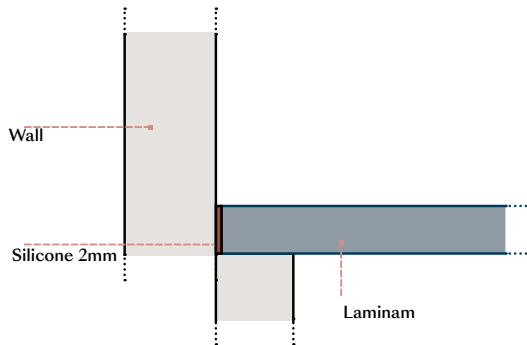
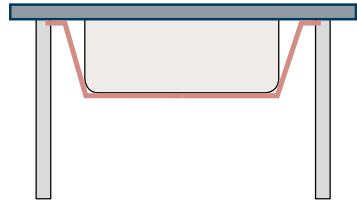

Use plastic film or adhesive rubber tape to protect the adjacent surface when applying the silicone. If the top consists of several sections, care should be taken when positioning them to avoid knocking the exposed edges. This operation can be facilitated by inserting spacers, to be removed once the slabs are in place. Join the two sections using silicone products, or clear or coloured adhesives, taking care to remove any residue after application.

When installing the basin, the edges should be sealed with silicone, adhesive seal or similar to ensure water tightness and to avoid the build-up of dirt. Depending on the type of basin to be installed, proceed with the mounting system provided by the manufacturer consisting of mechanical and/or adhesive fixing. Prepare two support bars or a similar system for supporting the sink to be mounted on the furniture unit, so that the top is not bearing the weight of the sink itself and the water it contains.

Installation of the hob must be centred within the opening provided, making sure to maintain an expansion gap.

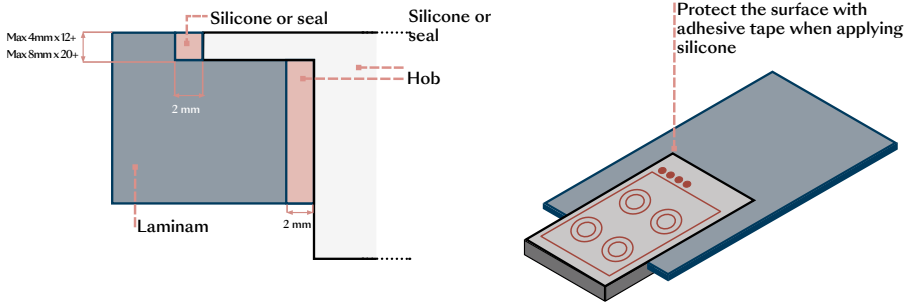

1.3 Cleaning after installation

Remove any residue of the silicone used for installation and for sealing appliances with a thinner and a soft sponge. Remove any cement-based residues left by work carried out on the back with an acidic product and a soft sponge.

Preliminary cleaning to sanitise the top before using it for the first time should be carried out by leaving an alkaline detergent to act for around 5/10 minutes. Proceed with a mechanical action using a soft, non-abrasive sponge, rinse with plenty of water, and dry the surface with a microfibre cloth.

This operation helps to eliminate any organic residues on the surface as a result of production, manufacture and installation of the top.

2 | Cleaning, use and maintenance

The natural origin and production process of Laminam slabs mean they have almost no surface porosity, making them easy to clean and suitable for use as a kitchen countertop and as table tops.

The same process makes the product hard and compact: during everyday use avoid knocks which could chip the top especially in more delicate areas such as corners, edges, integrated basins etc. Do not subject the top to improper use and avoid overloading it, for example by climbing on it, which may cause it to break, especially in vulnerable areas which have less support such as basins and hobs.

To clean Laminam surfaces, use warm water and, if necessary, mild detergents commonly used to clean kitchen countertops and appliances, with a microfibre cloth or soft sponge. If correctly maintained, the Laminam top will not require any special cleaning.

Note that in general stains are more easily removed the sooner they are dealt with. If left for a long time on the surfaces, some residues may require the use of a specific detergent. The choice of this detergent will depend on the type of stain: for food residues, use alkaline detergents (products with a higher pH such as ammonia or bleach), for inorganic residues, use acidic detergents (such as descaler) and for oily residues, use degreasers. Rinse the surface after using cleaning products to prevent the formation of streaks or films on the surface.

Staining agent	Everyday cleaning	Specific detergent for any stubborn residue
Wine	Warm water and mild detergent	Alkaline*
Ice-cream, Coffee, Tea, Tomato, Balsamic vinegar, Lemon, Coca-Cola, Beer, Milk, Fruit juice, Jam, Nicotine	Warm water and mild detergent	Alkaline*
Oil, Butter, Greasy and oily substances, Wax	Warm water and mild detergent	Degreaser
Rust, Limescale, Metal marks, Concrete residue, Plaster	Warm water and mild detergent	Acid
Nail polish	Warm water and mild detergent	Solvent

* If using bleach (alkaline detergent), dampen a soft cloth and rub the surface for a few seconds. Most of the stain will already no longer be visible 2/3 minutes after application. Alternatively, it can be poured directly onto the surface. Leave on polished surfaces for no longer than 10 minutes, without letting it dry. Repeat the operation until the stain is gone, taking care to rinse after every application.

Prescriptions

- Do not use fluorhydric acid or products containing it.
- Do not use abrasive sponges or metal wool.
- Always avoid cleaning agents containing abrasive particles on the Lucidate (polished)/Soft Touch surfaces.
- To remove stubborn stains, when using mildly abrasive products that cannot, however, be used on Lucidate (polished)/Soft Touch surfaces, ensure that the pressure applied does not have a polishing effect on the treated area.
- Do not use products that contain wax or polishes.
- When they are not promptly removed, staining agents might leave stains that are not entirely removable on the Lucidate (polished) surfaces.
- Metal objects, such as cutlery, saucepans and knives, might cause surface scratches on Lucidate (polished)/Soft Touch surfaces. Use trivets and cutting boards when preparing food.
- Avoid dragging/using objects with a hardness equal to or greater than ceramic on all surfaces as this could cause permanent scratches (e.g. ceramic knives, diamond tools, etc...).
- Laminam surfaces, with the exception of the Lucidate (polished)/Soft Touch ones, do not fear scratches caused by metal objects and cutlery. Having a lower degree of hardness, in case of rubbing, they might leave metal residue on the countertop. Such residue, which shall not be considered surface defects, might be hard to completely remove. They might be more evident on products with a black background.
- Avoid direct contact with the flame.

